

TOP VIEW

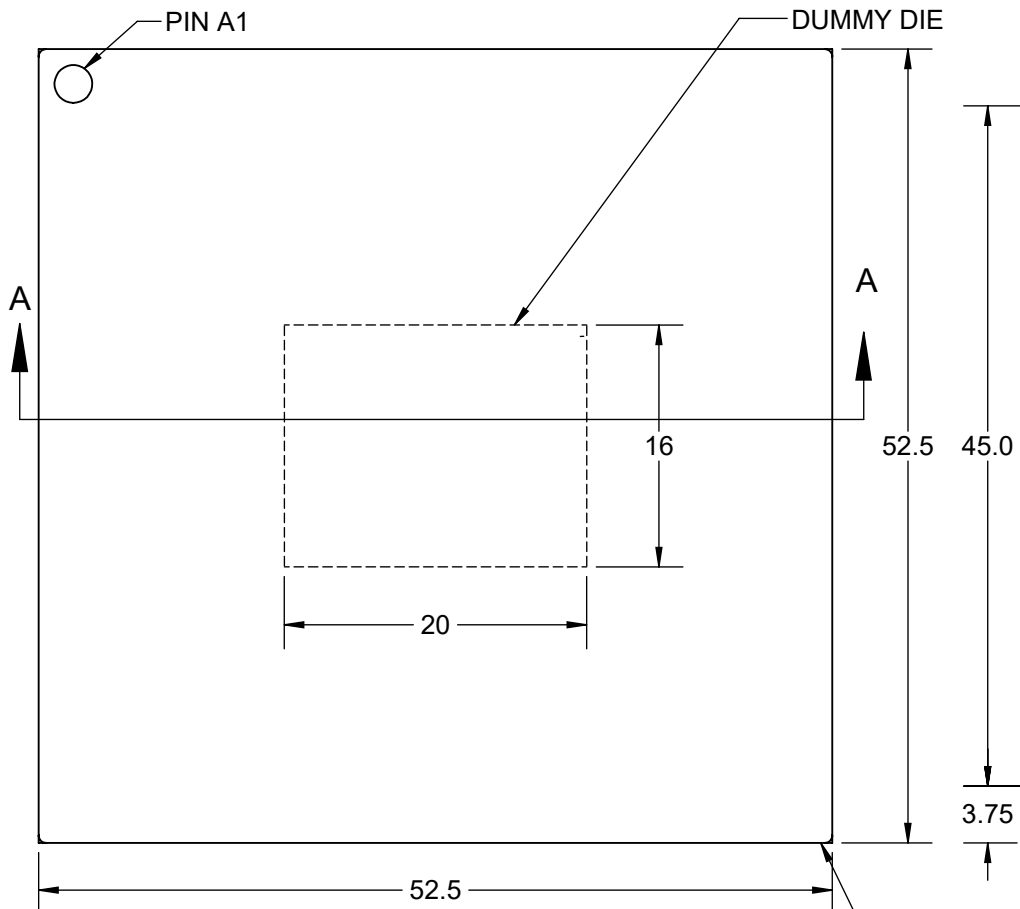

BALL VIEW

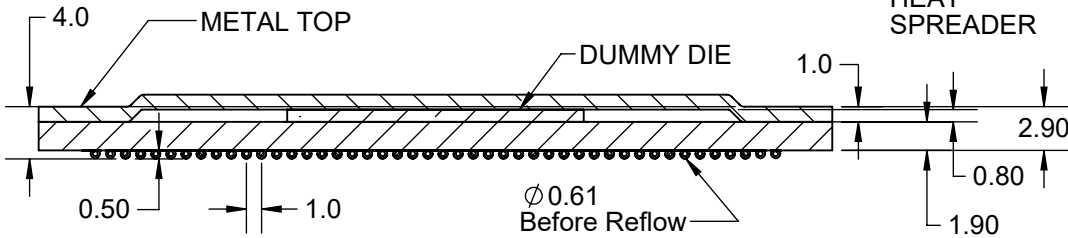
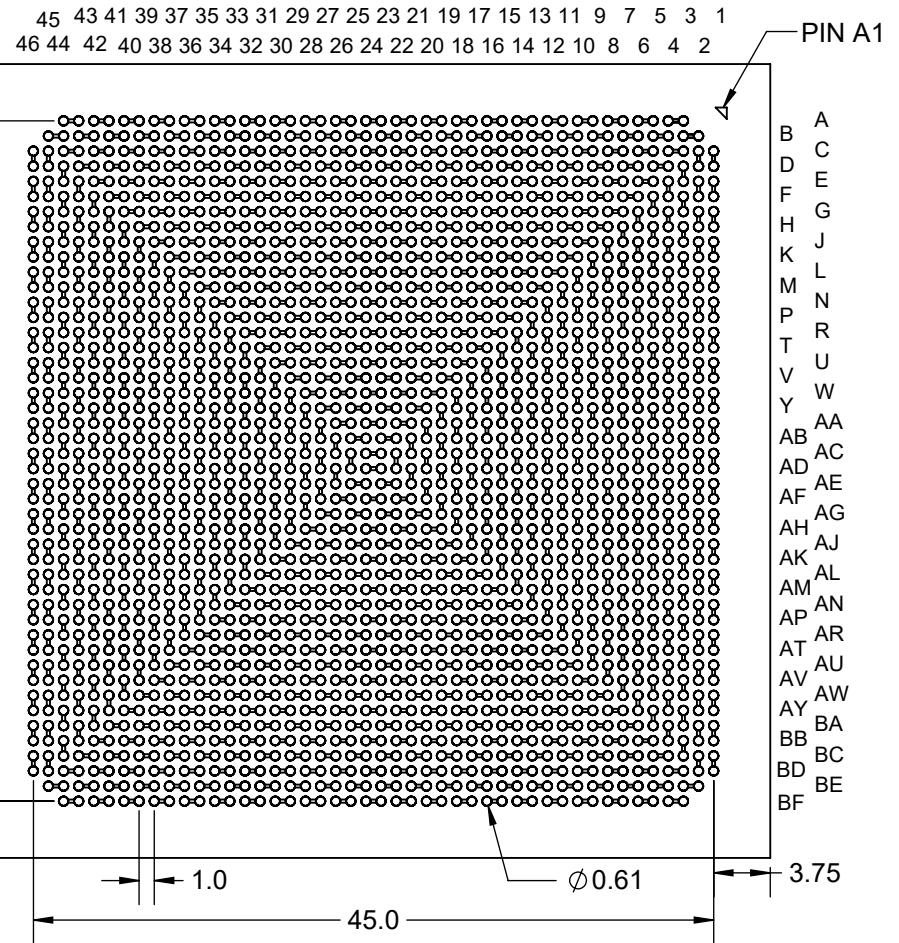

SECTION A-A

Notes: (Unless Otherwise Specified).

- 1) ALL DIMENSIONS ARE IN MM.
- 2) SOLDER BALL ALLOY: SEE PART NUMBER TABLE.
- 3) BALL DIAMETER (BEFORE REFLOW): 0.61mm (24 MIL).
- 4) SOLDER MASK DEFINED PAD OPENING: 0.508mm (20 MIL).
- 5) PAD Cu DIAMETER: 0.635mm (25 MIL).
- 6) SUBSTRATE MATERIAL: FR4 (ALTERNATE BT).
- 7) DUMMY DIE IS OPTIONAL.
- 8) DAISY CHAIN PATTERN (SEE PAGE 2).
- 9) MSL-3 RECOMMENDED BAKING 24 HOURS @ 125°C TO REMOVE MOISTURE PRIOR SOLDERING TO PC BOARD.

| PART NUMBER TABLE | | | | |
|----------------------|--------------------|------------|------|--------|
| PART NUMBER | BALL ALLOY | BALL ALLOY | RoHS | Si DIE |
| SBGA2104T1.0C-DC466D | Sn96.5/Ag3.0/Cu0.5 | SAC305 | YES | YES |
| SBGA2104T1.0-DC466D | Sn63/Pb37 | Sn63 | NO | YES |

| | | | | | |
|-------------|----------|------------------------------------------------|------|-------------|--------------|
| APPROVALS | DATE | TopLine® | | | |
| DRAWN T. Au | 9/6/2018 | | | | |
| ENG M. Hart | 9/6/2018 | TITLE SBGA2104T1.0-DC466D DAISY CHAIN DUMMY | | | |
| MFG | | SCALE | SIZE | DRAWING NO. | REV |
| QA | | 2:1 | A | 514664 | A |
| CUST | | DO NOT SCALE DRAWING | | | SHEET 1 OF 9 |
| REVISED | | | | | |

BALL VIEW

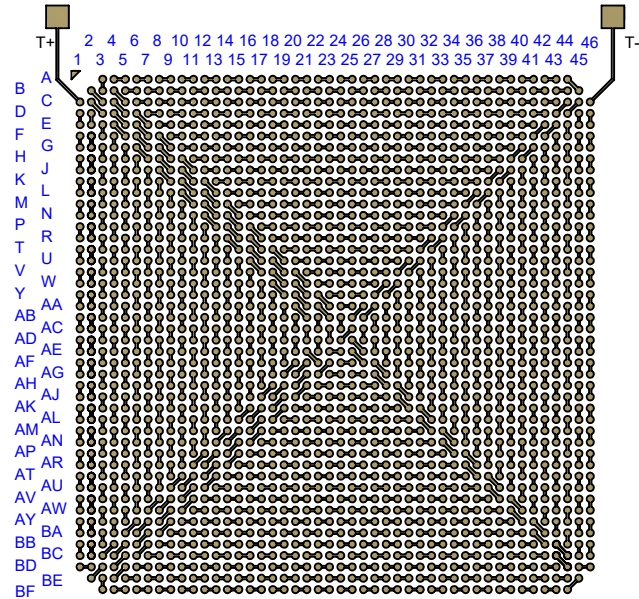
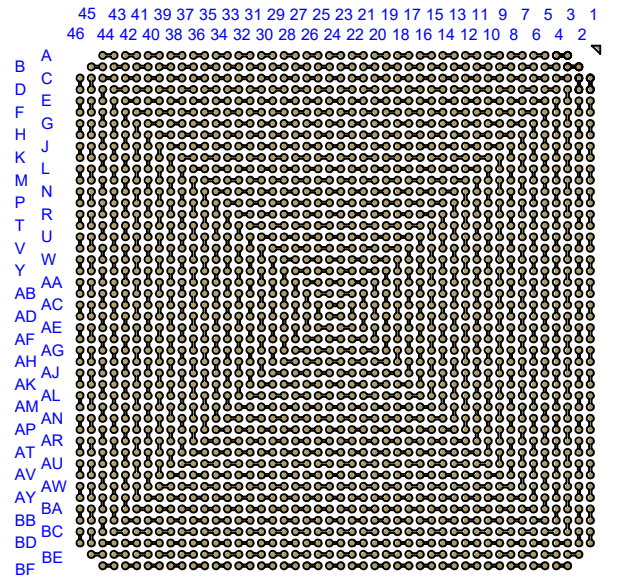

TEST VEHICLE BOARD

BOTTOM SIDE (TOP X-RAY VIEW)

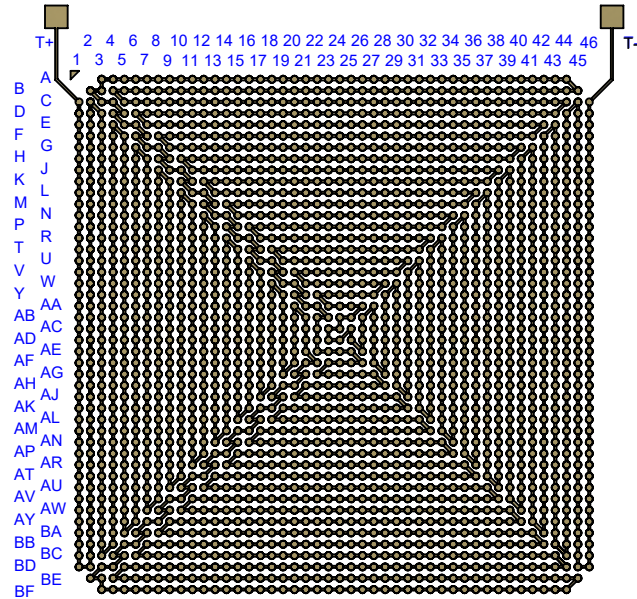
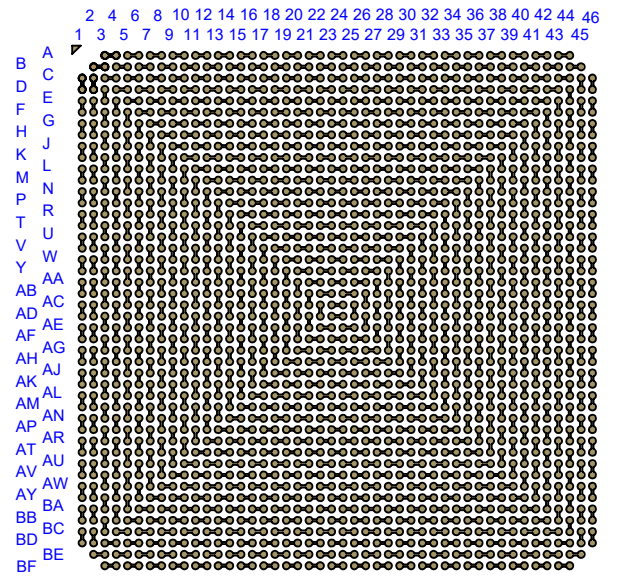

AFTER MOUNTING

Notes:

- 1) PCB BOARD DIMENSIONS ARE PRESENTD ONLY AS A GUIDELINE. DESIGNERS SHOULD USE THEIR OWN EXPERIENCE WHEN DESIGNING PCB.
- 2) PCB Cu BALL PAD DIAMETER 0.635mm [25 MIL].
- 3) PCB DAISY CHAIN TRACING LINE WIDTH 0.204mm [8 MIL].
- 4) SMD (SOLDER MASK DEFINED) PAD OPENING 0.508mm [20 MIL].

TopLine®

| | | | |
|------------------------------------------|------|-------------|--------------|
| TITLE | | | |
| SBGA2104T1.0-DC466D DAISY CHAIN DUMMY | | | |
| SCALE | SIZE | DRAWING NO. | REV |
| 3:2 | A | 514664 | A |
| DO NOT SCALE DRAWING | | | SHEET 2 OF 9 |

BALL VIEW

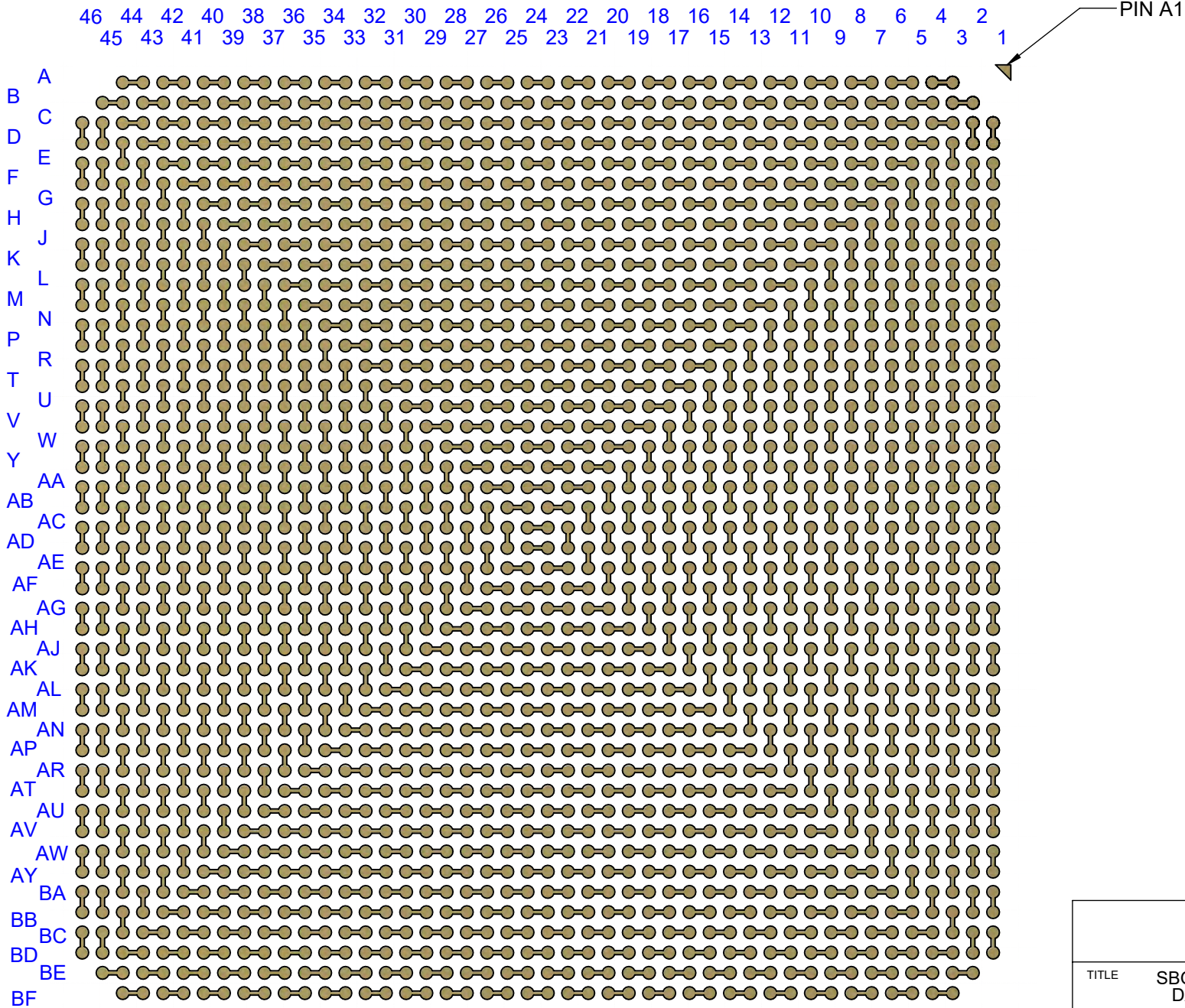

| | | | |
|------------------------------------------------|-----------|-----------------------|--------------|
| TopLine[®] | | | |
| TITLE SBGA2104T1.0-DC466D DAISY CHAIN DUMMY | | | |
| SCALE 3.5:1 | SIZE A | DRAWING NO. 514664 | REV A |
| DO NOT SCALE DRAWING | | | SHEET 3 OF 9 |

BOTTOM SIDE (TOP X-RAY VIEW)

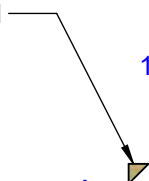
PIN A1 

1 3 5 7 9 11 13 15 17 19 21 23 25 27 29 31 33 35 37 39 41 43 45
2 4 6 8 10 12 14 16 18 20 22 24 26 28 30 32 34 36 38 40 42 44 46



TopLine®

| | | | |
|------------------------------------------|------|-------------|--------------|
| TITLE | | | |
| SBGA2104T1.0-DC466D DAISY CHAIN DUMMY | | | |
| SCALE | SIZE | DRAWING NO. | REV |
| 3.5:1 | A | 514664 | A |
| DO NOT SCALE DRAWING | | | SHEET 4 OF 9 |

T+

TEST VEHICLE BOARD

T-

1 3 5 7 9 11 13 15 17 19 21 23 25 27 29 31 33 35 37 39 41 43 45
 2 4 6 8 10 12 14 16 18 20 22 24 26 28 30 32 34 36 38 40 42 44 46

A
B
C
D
E
F
G
H
J
K
L
M
N
P
R
T
U
V
W
Y
AA
AB
AC
AD
AE
AF
AG
AH
AJ
AK
AL
AM
AN
AP
AR
AT
AU
AV
AW
AY
BA
BB
BC
BD
BE
BF

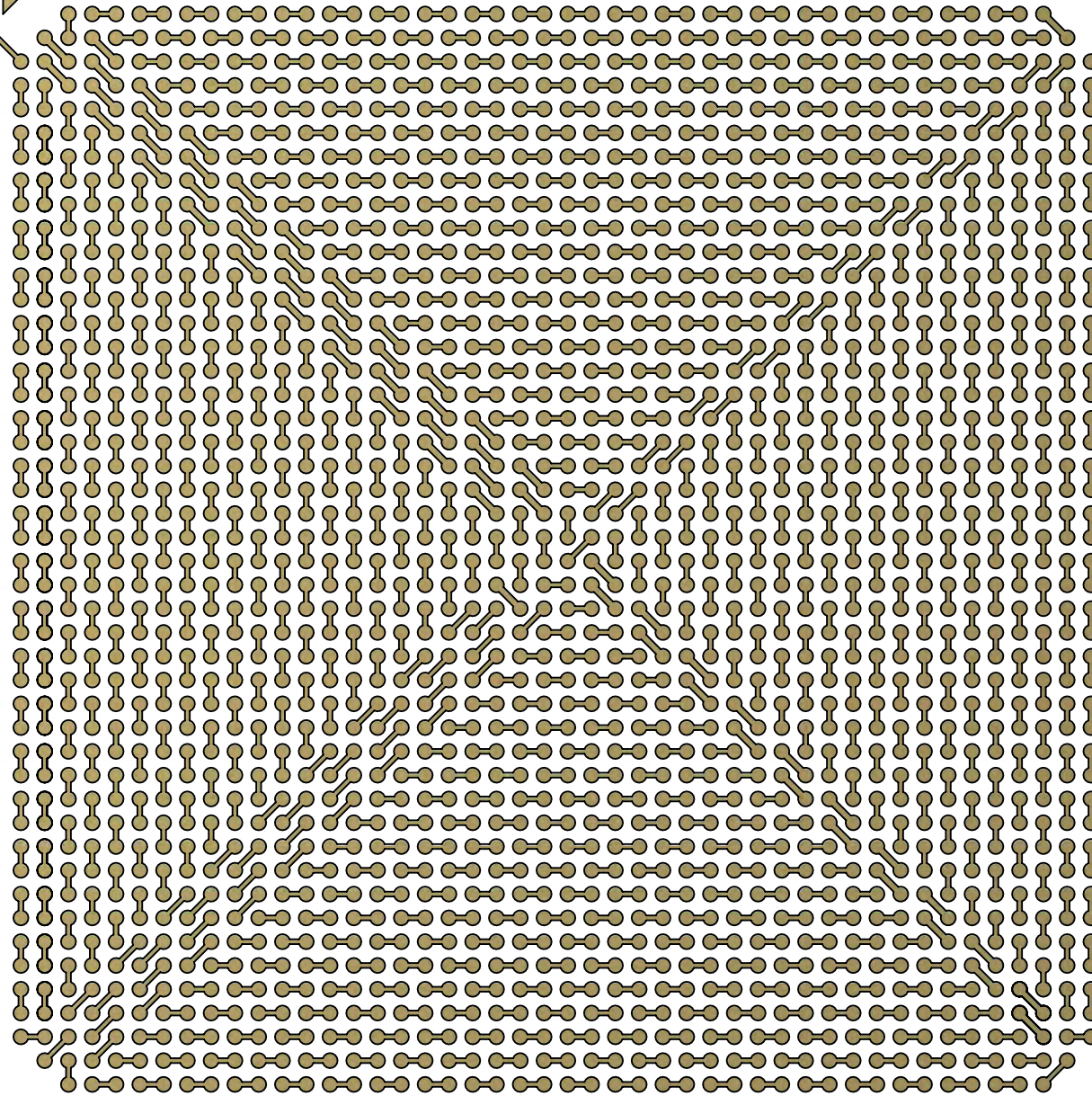

Notes:

- 1) PCB BOARD DIMENSIONS ARE PRESENTD ONLY AS A GUIDELINE. DESIGNERS SHOULD USE THEIR OWN EXPERIENCE WHEN DESIGNING PCB.
- 2) PCB Cu BALL PAD DIAMETER 0.635mm [25 MIL].
- 3) PCB DAISY CHAIN TRACING LINE WIDTH 0.204mm [8 MIL].
- 4) SMD (SOLDER MASK DEFINED) PAD OPENING 0.508mm [20 MIL].

TopLine[®]

TITLE SBGA2104T1.0-DC466D
DAISY CHAIN DUMMY

| SCALE | SIZE | DRAWING NO. | REV |
|-------|------|-------------|-----|
| 3.5:1 | A | 514664 | A |

DO NOT SCALE DRAWING

SHEET 5 OF 9

AFTER MOUNTING

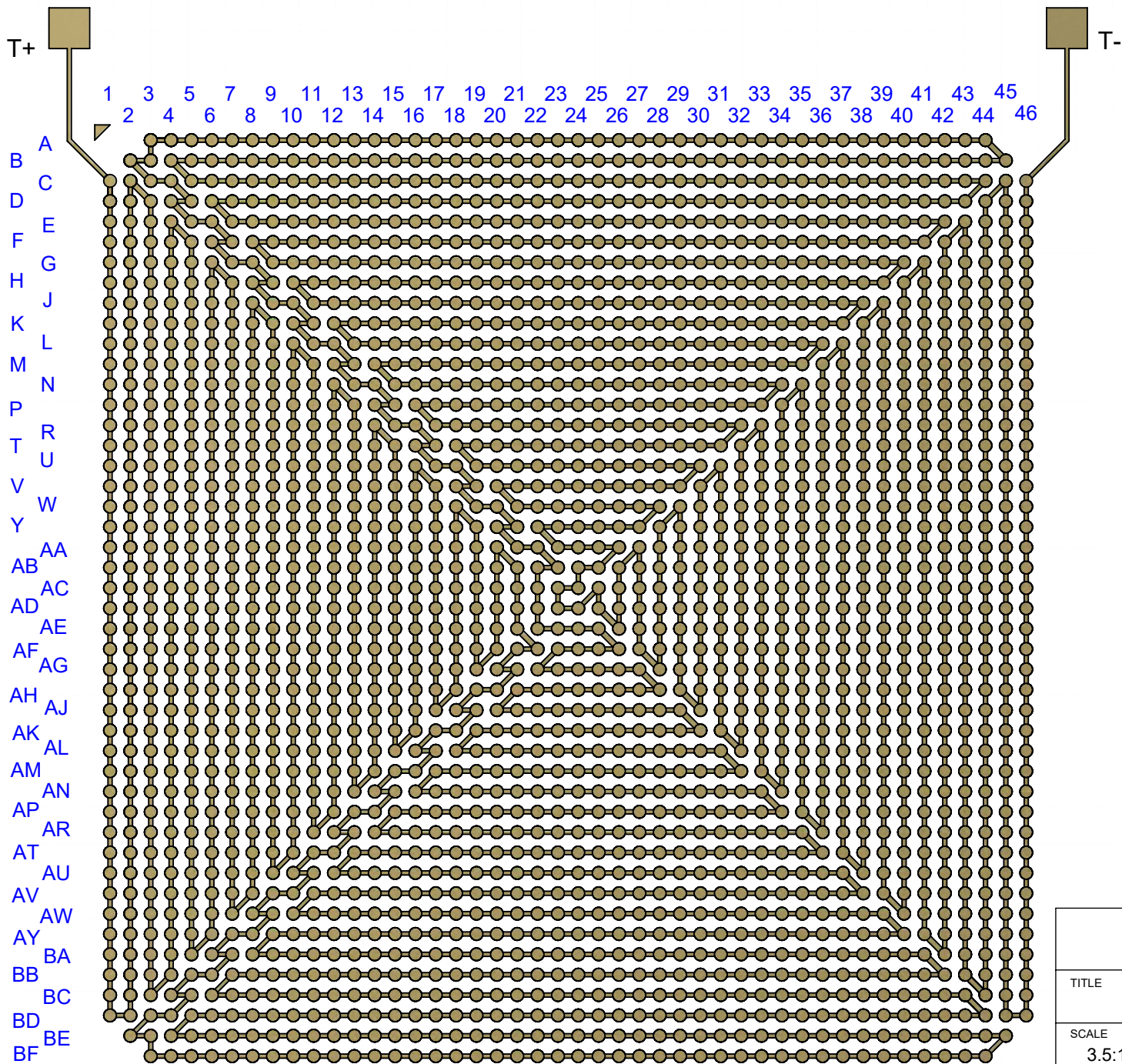

TopLine[®]

TITLE SBGA2104T1.0-DC466D
DAISY CHAIN DUMMY

| SCALE | SIZE | DRAWING NO. | REV |
|-------|------|-------------|-----|
| 3.5:1 | A | 514664 | A |

DO NOT SCALE DRAWING

SHEET 6 OF 9

HEAT SPREADER

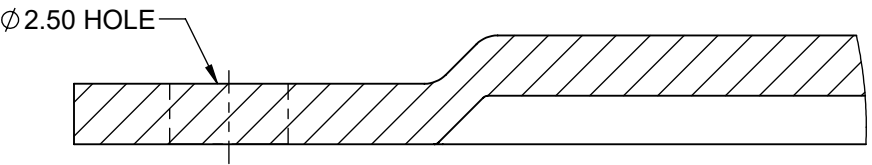
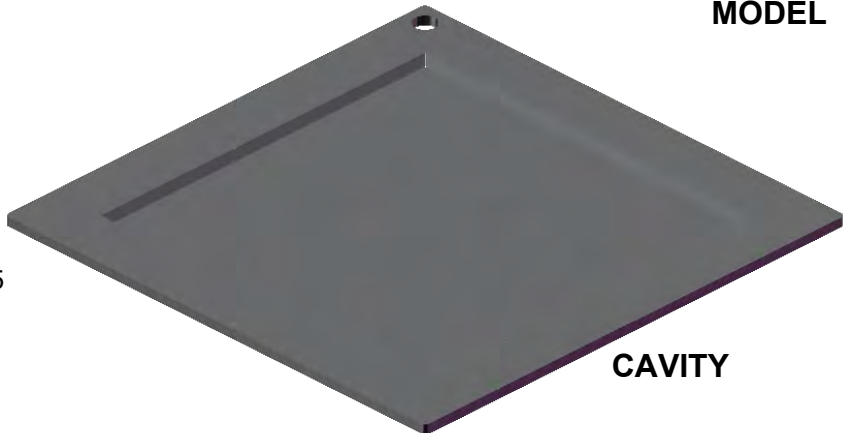
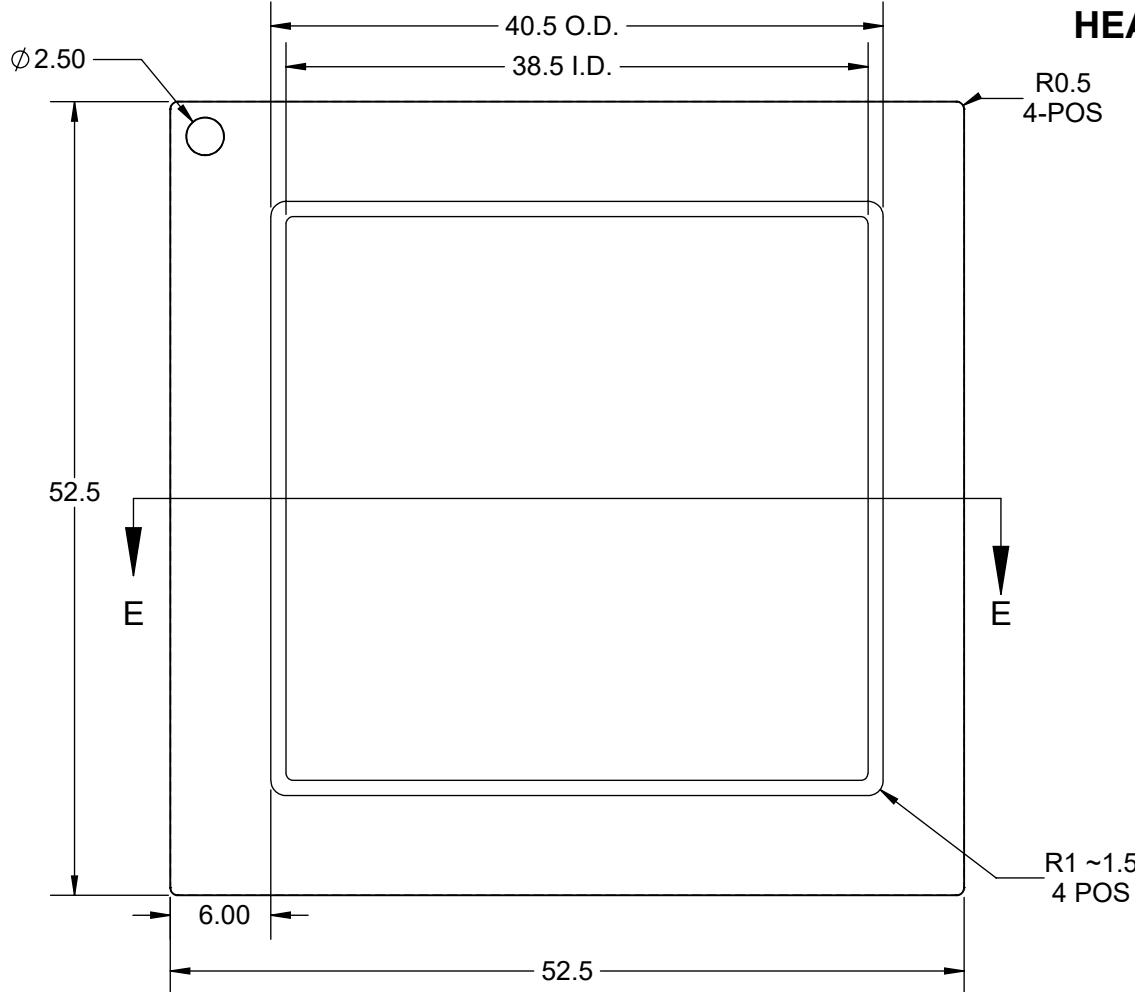

DETAIL F

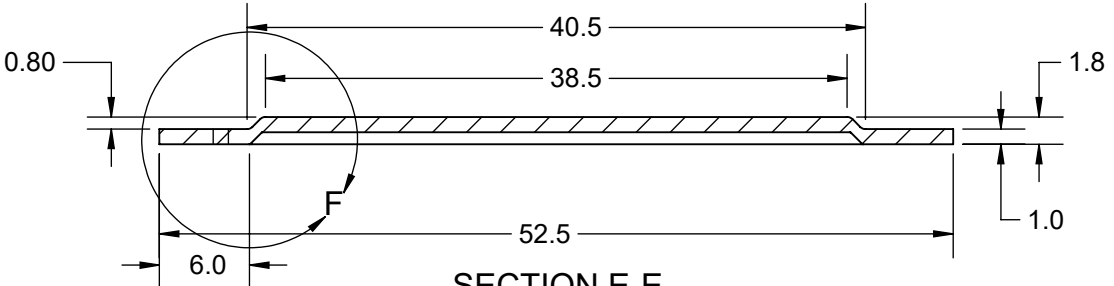

SECTION E-E

| | | | |
|------------------------------------------------|-----------|-----------------------|--------------|
| TopLine® | | | |
| TITLE SBGA2104T1.0-DC466D DAISY CHAIN DUMMY | | | |
| SCALE 3:1 | SIZE A | DRAWING NO. 514664 | REV A |
| DO NOT SCALE DRAWING | | | SHEET 7 OF 9 |

MODEL

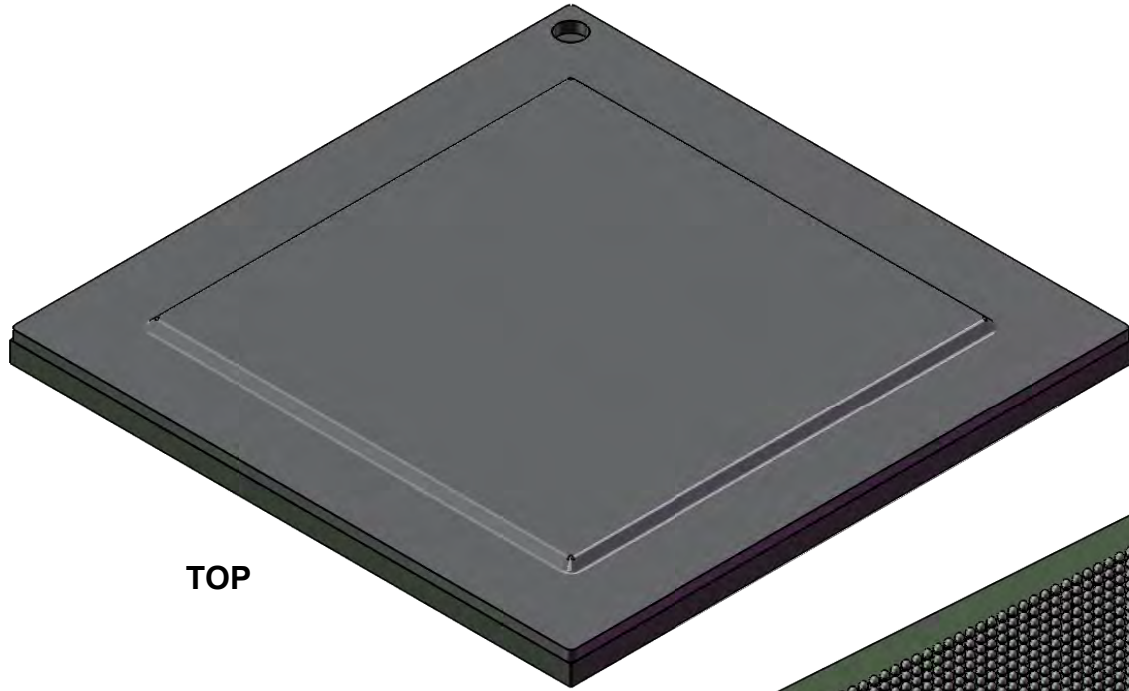

TOP

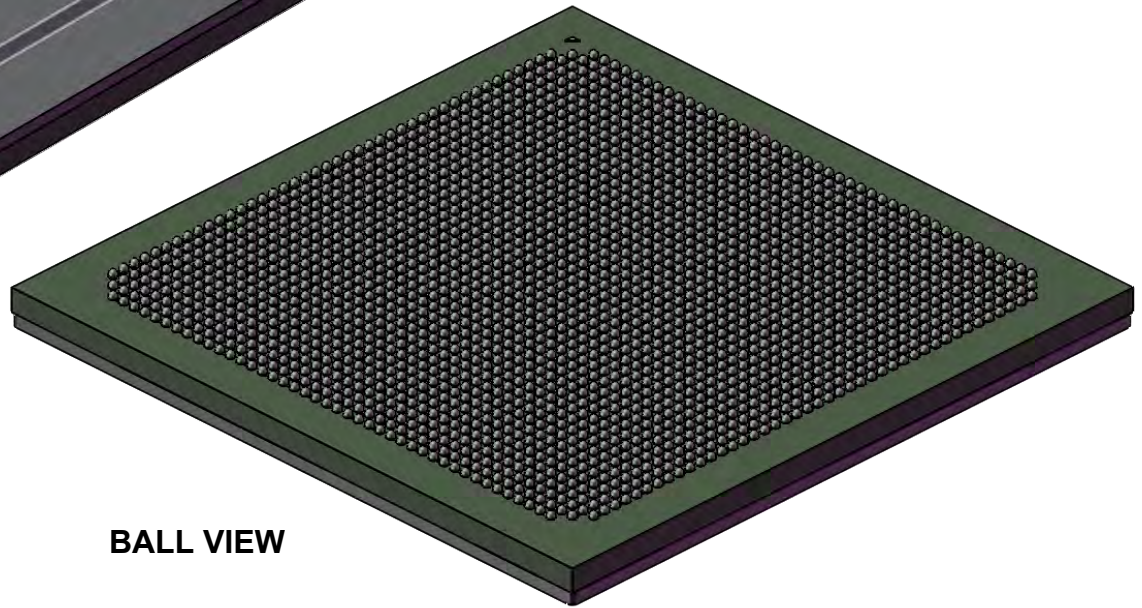

BALL VIEW

TopLine[®]

TITLE SBGA2104T1.0-DC466D
DAISY CHAIN DUMMY

| | | | |
|--------------|-----------|-----------------------|----------|
| SCALE 2:1 | SIZE A | DRAWING NO. 514664 | REV A |
|--------------|-----------|-----------------------|----------|

DO NOT SCALE DRAWING

SHEET 8 OF 9

BOTTOM SOLDER MASK (RIGHT READING)

46 44 42 40 38 36 34 32 30 28 26 24 22 20 18 16 14 12 10 8 6 4 2
45 43 41 39 37 35 33 31 29 27 25 23 21 19 17 15 13 11 9 7 5 3 1

A
B C
D E
F G
H J
K L
M N
P R
T U
V W
Y AA
AB AC
AD AE
AF AG
AH AJ
AK AL
AM AN
AP AR
AT AU
AV AW
AY BA
BB BC
BD BE
BF

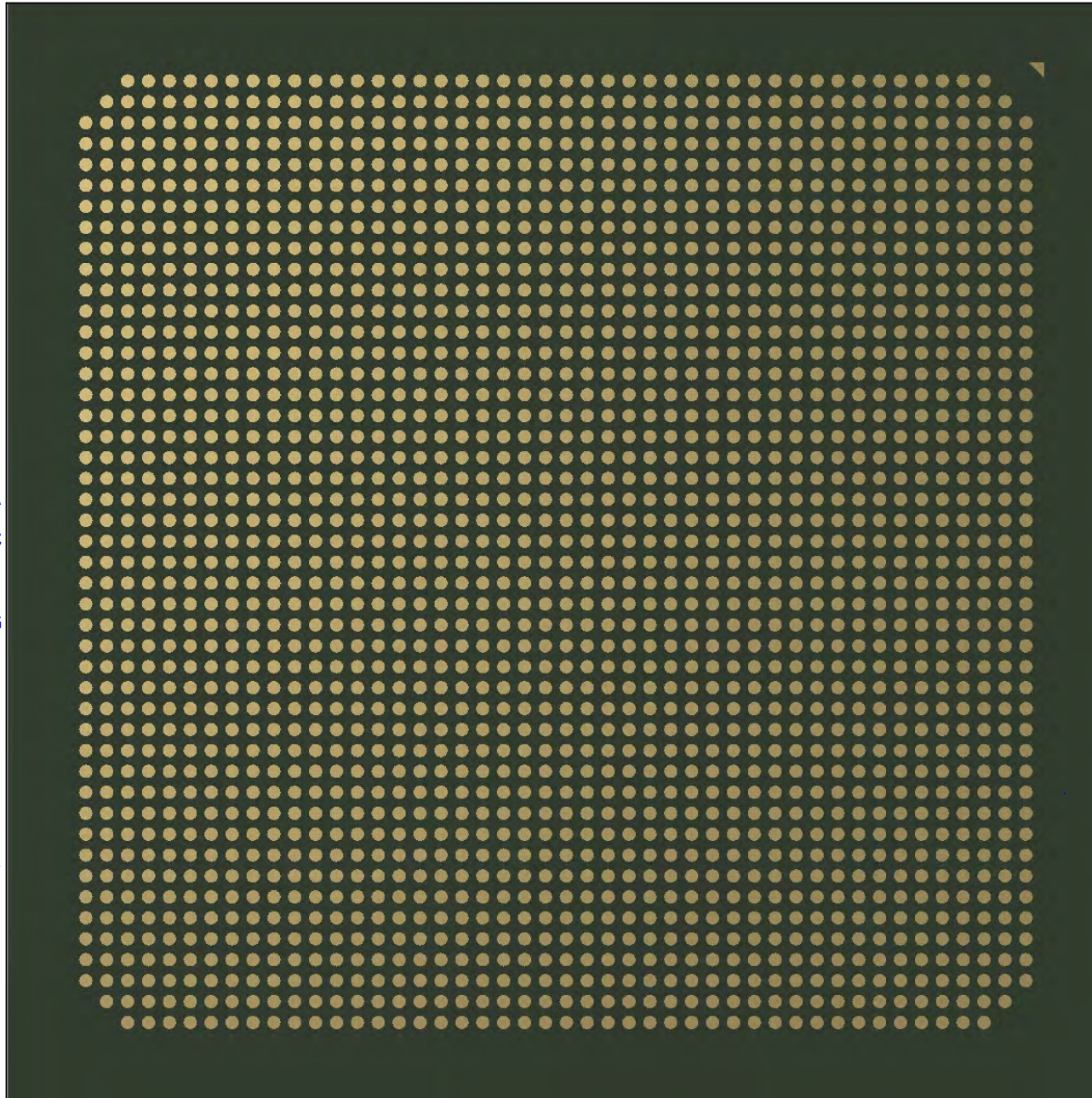

| | | | |
|----------------------|------|------------------------------------------|--------------|
| TopLine® | | | |
| TITLE | | SbGA2104T1.0-DC466D DAISY CHAIN DUMMY | |
| SCALE | SIZE | DRAWING NO. | REV |
| 3.75:1 | A | 514664 | A |
| DO NOT SCALE DRAWING | | | SHEET 9 OF 9 |